

Best viewed in landscape mode

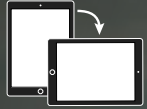

THE

4

GRAN COUPÉ





# THE BMW 4 SERIES GRAN COUPÉ.

RETURN BY CLICKING [🏠](#)  
SELECT A TOPIC BELOW TO EXPLORE:



## FEATURED MODEL.

### BMW 440i M SPORT GRAN COUPÉ:

BMW TwinPower Turbo six-cylinder in-line petrol engine, 326hp (240kW), 19" M light alloy Double-spoke style 704 M wheels with mixed tyres, exterior colour in Frozen Silver metallic.

Content correct at time of publishing (as of January 2021). Prices and technical data subject to change. The models shown on these pages may feature optional equipment. Standard equipment may also vary depending on engine variant. For further details, please contact your local BMW Centre.





IDEAL LINES







IRRESISTIBLE



M SPORT.



The BMW 4 Series M Sport Gran Coupé is shown above in BMW Individual Frozen Silver metallic paint.

■ Standard equipment □ Optional equipment



# M SPORT.

In addition / replacement to Sport models

## EXTERIOR

- 18" M light alloy Double-spoke style 400 M wheels
- Metallic paint (440i only)
- Exterior trim, High-gloss Shadowline
- M aerodynamic bodystyling
- Air Breather, High-gloss Black
- Kidney grille – Chrome with extra-wide Black, High-gloss vertical slats
- Exhaust tailpipe – dual, left, with Chrome finisher
- Side exterior M designation badges

## INTERIOR

- M Sport instrument cluster
- M Sport multi-function leather steering wheel, three-spoke
- Seat adjustment – front, electric with driver memory (440i only)
- Interior trim, Aluminium Hexagon with Estoril Blue finisher
- Door sill finishers with M designation
- Headlining, Anthracite
- M gear selector lever in Nappa leather (manual transmission)
- Remote control, including integrated key, with inset in Blue

## SAFETY & TECHNOLOGY

- M Sport suspension (excluding xDrive models)
- Eight-speed Sport automatic transmission (excludes 420i)
- Six-speed manual transmission (420i only)



SPORT.



The BMW 4 Series Sport Gran Coupé model is shown above in Mineral Grey metallic paint.

■ Standard equipment □ Optional equipment



# SPORT.

## EXTERIOR

- 18" light alloy Double-spoke style 397 wheels, Bicolour Orbit Grey
- Air Breather, High-gloss Black
- Exterior trim, High-gloss Black
- Kidney grille, Chrome with extra-wide Black, High-gloss vertical slats
- Exhaust tailpipe – dual, left, with Dark Chrome finisher

## INTERIOR

- Air conditioning, automatic with two-zone control
- Interior trim, High-gloss Black with Pearl Chrome highlight
- Sport seats, front
- Seat heating for driver and front passenger
- Split-folding rear seats, 60:40
- Sport instrument cluster with Red highlight and chrono scale
- Sport multi-function leather steering wheel, three-spoke with Red stitching
- Ambient lighting – switchable BMW Classic Orange / Cold White LED
- Armrest – front, folding with storage compartment
- Centre console panel highlight in Chrome
- Door sill finishers with BMW designation
- Extended lighting
- Remote control, including integrated key, with inset in Red

## SAFETY & TECHNOLOGY

- Eight-speed Sport automatic transmission (excludes 420i)
- Drive Performance Control
- LED foglights, front
- LED headlights
- LED tail lights with dynamic brake lights
- Park Distance Control (PDC), front and rear
- Six-speed manual transmission (420i only)
- Tyre Pressure Monitor

## AUDIO & COMMUNICATION

- BMW ConnectedDrive, comprising:
  - BMW Emergency Call
  - BMW Navigation System
  - BMW Online Services
  - BMW TeleServices
  - Real Time Traffic Information (RTTI)
  - Remote Services
- Bluetooth hands-free facility with USB audio interface and Bluetooth audio streaming





# EXTERIOR COLOURS.

## ALL MODELS.



Non-metallic Alpine White

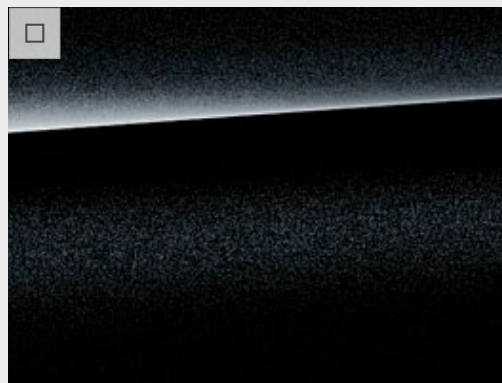

Metallic Black Sapphire



Metallic Mineral Grey

## EXCLUSIVELY FOR SPORT MODELS.



Metallic Glacier Silver



Metallic Mineral White

## EXCLUSIVELY FOR M SPORT MODELS.



Metallic Estoril Blue



Metallic Snapper Rocks Blue



BMW Individual Aventurine Red II

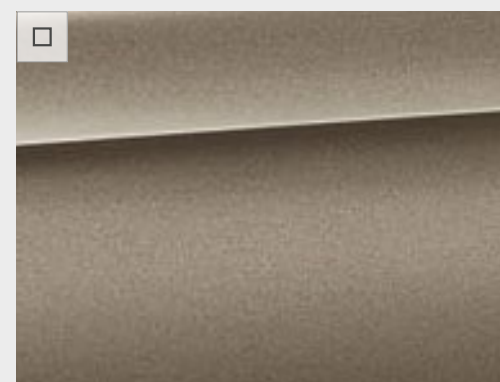

BMW Individual Frozen Bronze metallic



BMW Individual Tanzanite Blue metallic

**Colour samples** These colour samples are intended as an initial guide to the colours and materials available for your BMW. Please discuss your preferred colour choices with your BMW Centre. There you can also see original samples and be assisted with any requests.

■ Standard equipment □ Optional equipment



# UPHOLSTERY.

## LEATHER.



Dakota leather in Black with a Black interior world

Available with  
 Sport  
 M Sport



Dakota leather in Ivory White with Oyster highlight, with a Black interior world

Available with  
 Sport  
 M Sport



Dakota leather in Black with Red highlight, with a Black interior world

Available with  
 Sport



Dakota leather in Coral Red with Black highlight, with a Black interior world

Available with  
 Sport  
 M Sport



Dakota leather in Black with Oyster highlight, with a Black interior world

Available with  
 Sport  
 M Sport



Dakota leather in Mocha with a Black interior world

Available with  
 Sport  
 M Sport

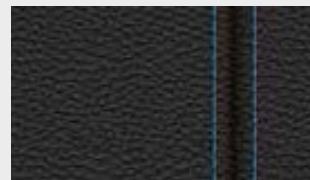

Dakota leather in Black with Blue contrast stitching, with a Black interior world

Available with  
 M Sport

## BMW INDIVIDUAL.



Merino leather in Opal White<sup>1</sup>

Available with  
 M Sport



Merino leather in Cashmere Beige<sup>1</sup>

Available with  
 M Sport



Merino leather in Golden Brown<sup>1</sup>

Available with  
 M Sport



Merino leather in Nutmeg<sup>1</sup>

Available with  
 M Sport

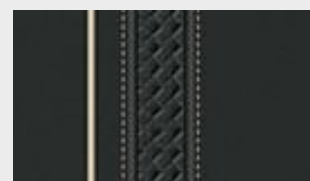

Merino leather in Black<sup>1</sup>

Available with  
 M Sport

<sup>1</sup> = BMW Individual Merino leather upholstery with contrast stitching and piping comprises front and rear seats including headrests, door trim inserts, door armrests, central armrest. Piping on front and rear seats and headrests in contrasting colour.



# INTERIOR TRIMS.



High-gloss Black with Pearl Chrome highlight

Available with  
■ Sport

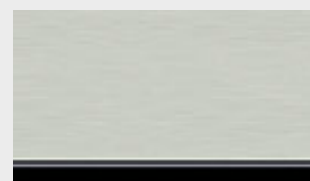

Brushed Aluminium with High-gloss Black highlight

Available with  
 Sport  
 M Sport



Aluminium Hexagon with Estoril Blue highlight

Available with  
■ M Sport

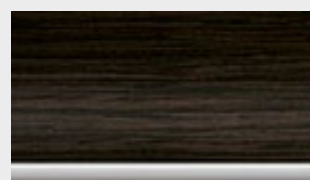

Fineline Anthracite wood with Pearl Chrome highlight

Available with  
 M Sport



Aluminium Carbon with Pearl Chrome highlight

Available with  
 M Sport

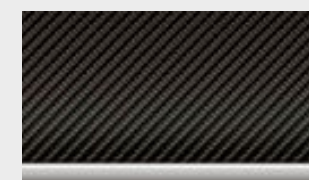

Carbon Fibre<sup>1</sup>

Available with  
 M Sport

<sup>1</sup> = Exclusively available as part of the M Sport Plus Package.

## BMW INDIVIDUAL.

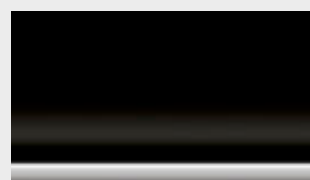

Piano Black with Pearl Chrome finisher

Available with  
 M Sport

## HEADLINING.

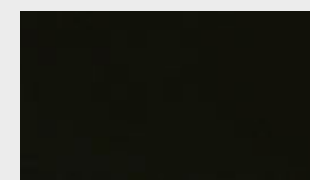

Anthracite

Available with  
 Sport  
■ M Sport



# PACKAGES.

Optional packages offer an attractive combination of the most popular options at a reduced (combined) cost and will enhance any journey in the BMW 4 Series Gran Coupé.

## COMFORT PACKAGE

- Comprises:
- Comfort Access
  - Extended storage
  - Steering wheel heating



## DRIVING ASSISTANT PACKAGE

- Comprises:
- Active cruise control with Stop&Go function
  - Driving Assistant:
  - City Collision Mitigation
  - Forward Collision Warning
  - Lane Departure Warning
  - Preventive Pedestrian Protection
  - Lane change warning system

Only with Technology Package and Exterior mirrors – folding with anti-dazzle.



## M SPORT PLUS PACKAGE

- Comprises:
- 19" M Double-spoke style 704 M wheels, Bicolour Jet Black
  - BMW Individual High-gloss Shadowline with extended contents
  - Digital Cockpit
  - Loudspeaker system – harman/kardon
  - M seat belts
  - M Sport braking system
  - Mirror caps, High-gloss Black
  - Sun protection glass
- Differing content:
- 19" M Double-spoke style 704 M wheels, Ferric Grey

Exclusively available for M Sport models.



## PARK ASSIST PACKAGE

- Comprises:
- Exterior mirrors – folding with anti-dazzle
  - Park Assist
  - Reversing Assist camera
  - Surround view



## PREMIUM PACKAGE

- Comprises:
- Electric glass sunroof
  - Lumbar support, driver and front passenger
  - Seat adjustment – front, electric with driver memory



## TECHNOLOGY PACKAGE

- Comprises:
- Sport models:
- Enhanced Bluetooth with wireless charging
  - Full Black Panel Display
  - Head-up Display
  - Navigation system – BMW Professional Multimedia
  - Speed limit display
  - WiFi hotspot preparation
- M Sport models:
- Enhanced Bluetooth with wireless charging
  - Head-up Display
  - Speed limit display
  - WiFi hotspot preparation



## VISIBILITY PACKAGE

- Comprises:
- BMW Icon Adaptive LED Headlights
  - High-beam Assistant





# OPTIONAL EQUIPMENT HIGHLIGHTS.

## BMW ICON ADAPTIVE LED HEADLIGHTS.

The BMW Icon Adaptive LED Headlights adjust their light distribution according to speed and steering angle, lights and Adaptive headlights.

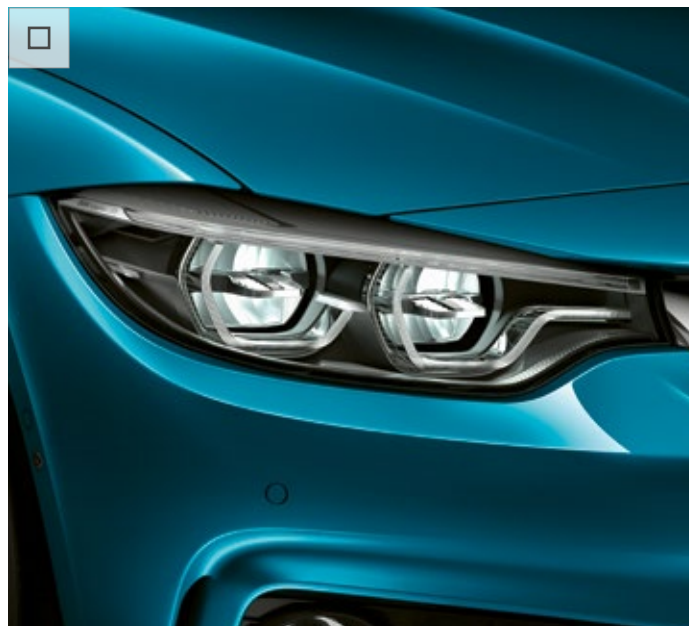

Exclusively available as part of Visibility Package.

## COMFORT ACCESS.

Comfort Access allows keyless entry to the vehicle via the driver and passenger doors as well as the bootlid. The key, which can be carried in a trouser pocket or handbag, for example, is automatically recognised as soon as it is in close proximity to the car.

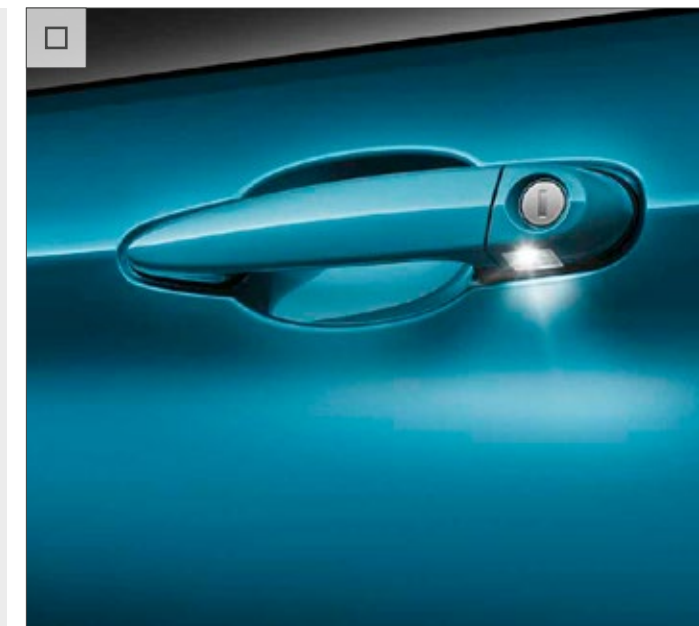

Exclusively available as part of Comfort Package.

## M SPORT BRAKING SYSTEM.

The M Sport braking system has four-piston fixed calipers at the front and two-piston floating calipers at the rear, in Blue with M designation, and features large brake discs to ensure an outstanding braking performance.

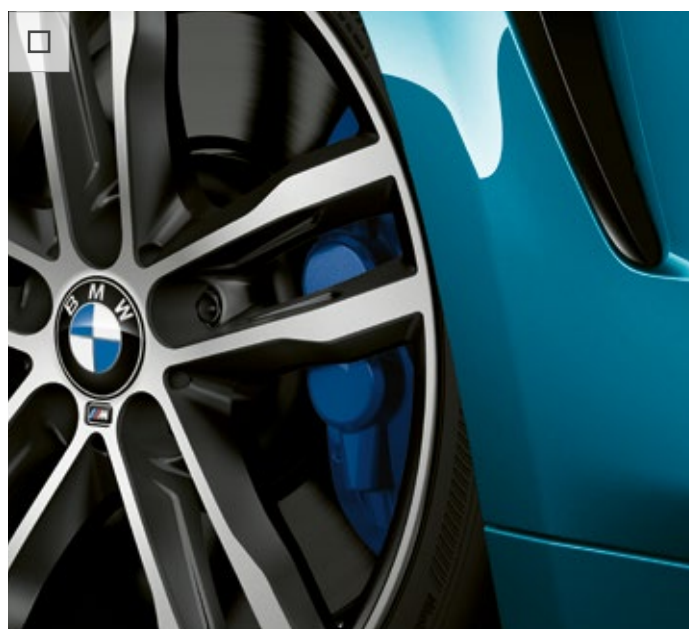

Exclusively available as part of M Sport Plus Package.

## ENHANCED BLUETOOTH WITH WIRELESS CHARGING.

Enhanced Bluetooth with wireless charging offers a comprehensive telephony package with Bluetooth connectivity and the technical capacity for a WiFi hotspot.



Also available as part of Technology Package. For Smartphones without an inductive charging function, special charging cases are available to purchase via BMW Parts and Accessories.

## ELECTRIC GLASS SUNROOF.

The Electric glass sunroof with sun protection offers a bright interior atmosphere and a generous sense of space. Convenient opening and closing of the sunroof can be operated via remote key and one-touch function.



Exclusively available as part of Premium Package.

## LOUDSPEAKER SYSTEM - HARMAN/KARDON.

The outstanding harman/kardon loudspeaker system features a 600 watt digital amplifier, 9 channels and 16 loudspeakers with chrome detailing. Its sophisticated sound perfectly fills the interior space. Vehicle-specific, speed-dependent equalising precisely compensates for any background driving noise.

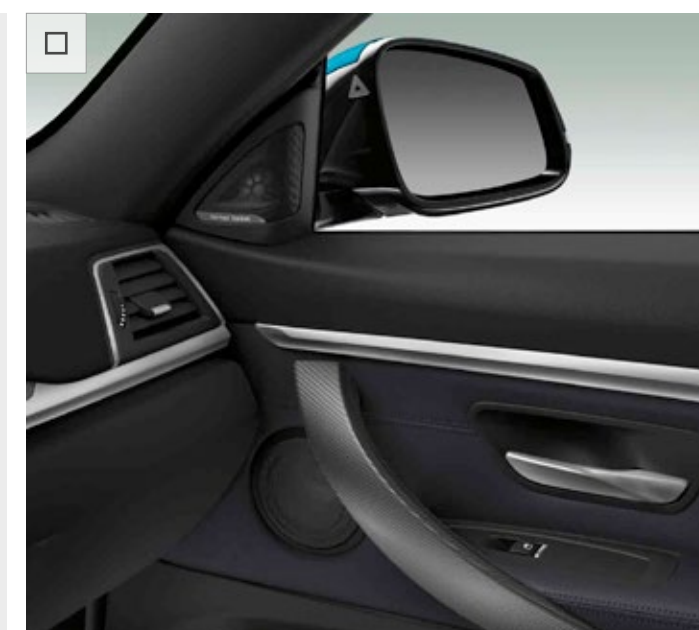

Also available as part of M Sport Plus Package.



# BMW CONNECTED DRIVE.

The BMW ConnectedDrive Services & Apps are on hand to make sure you have more time for the important things in life. Various innovations by BMW make things more convenient for you every day – whenever you want.

□ **Amazon Echo** gives you the ability to communicate with your vehicle using Voice Control and access your agenda from home.



□ **Door to door guidance** provides detailed walking directions from your parking spot to your destination. A map with a location pin also shows where you last parked once you're ready to head back to your car.



■ **Estimated time of arrival** provides you with detailed updates of your regular routes and alternative options so you can manage your journey and avoid delays.



■ With **Learned destinations** BMW Connected learns your most frequently travelled routes and provides them as future suggestions. If destinations are repeatedly visited, they are automatically listed at the usual time.



■ **Remote Services** enables you to use a smartphone to locate where your BMW is parked, to remotely lock and unlock the car and much more.



□ **Time to leave** function provides notifications on your Apple iPhone®, compatible Android phone, your Apple Watch® or Samsung Gear S3® watch, and recommends a time to leave to help you arrive on time.



□ **Apple CarPlay® preparation** enables wireless and comfortable usage of your iPhone® in your vehicle via Apple CarPlay®. Selected smartphone content can be displayed and operated via the user interface of the vehicle.

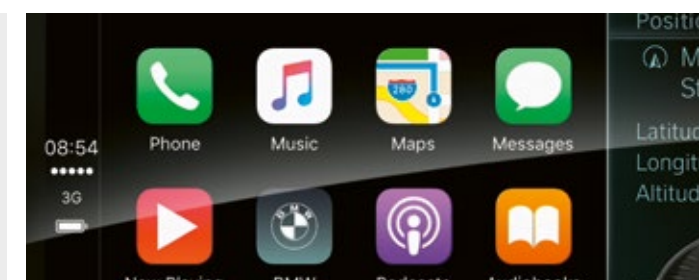

■ **BMW Emergency Call** automatically establishes a voice connection with the local emergency services without the use of a mobile phone. It transmits information about the vehicle's current location and can be triggered manually in case other road users require help.

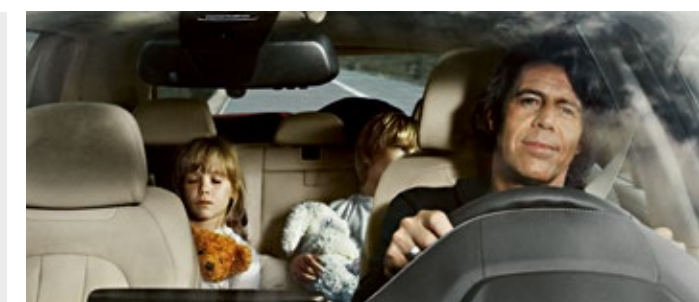

□ With **Online Entertainment** you have direct and unlimited access to millions of songs without the need for a mobile or MP3 device in the vehicle. Online Entertainment is a Music on Demand function that uses the built-in vehicle SIM.



□ **Concierge Services** connects the driver to a BMW Call Centre agent who acts as their personal assistant at the touch of a button. The agent can locate a particular restaurant, for example, and send the address directly to the BMW's navigation system.



■ **Real Time Traffic Information (RTTI)** collects current traffic information about motorways, main and country roads and urban routes. It relays information about delays and dangers and suggests the best alternative routes.



## MY BMW APP.

The My BMW App is the direct connection inside and outside your BMW. Plan your next trip, check the status of your vehicle or use one of the remote service functions – all conveniently from your smartphone.

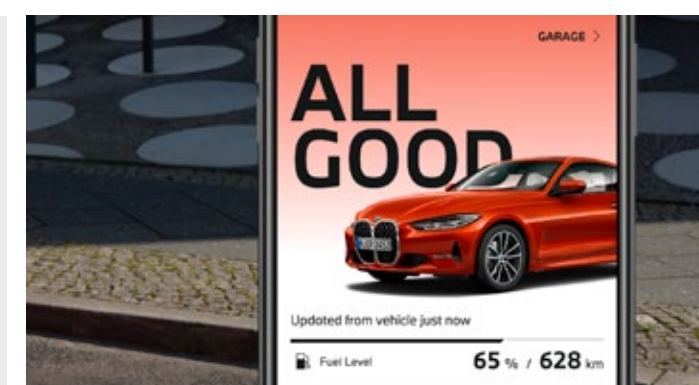



# WHEELS & TYRES.

## 19" M LIGHT ALLOY DOUBLE-SPOKE STYLE 704 M WHEELS.

19" M light alloy Double-spoke style 704 M wheels with mixed run-flat tyres, front 8J x 19 with 225/40 R19 tyres and rear 8.5J x 19 with 255/35 R19.

Exclusively available as part of M Sport Plus Package as a pack alternative.



## 19" M LIGHT ALLOY STAR-SPOKE STYLE 403 M WHEELS.

19" M light alloy Star-spoke style 403 M wheels, front 8J x 19 with 225/40 R19 tyres, rear 8.5J x 19 with 255/35 R19 run-flat tyres.

Optional for M Sport models.



## 19" M LIGHT ALLOY DOUBLE-SPOKE STYLE 704 M WHEELS, BICOLOUR JET BLACK.

19" M light alloy Double-spoke style 704 M wheels, Bicolour Jet Black with mixed tyres, front 8J x 19 with 225/40 R19 tyres, rear 8.5J x 19 with 255/35 R19 tyres.

Exclusively available as part of M Sport Plus Package.



## 18" LIGHT ALLOY DOUBLE-SPOKE STYLE 397 WHEELS, BICOLOUR ORBIT GREY.

18" light alloy Double-spoke style 397 wheels, Bicolour Orbit Grey, 8J x 18 with 225/45 R18 tyres.

Standard for Sport models.

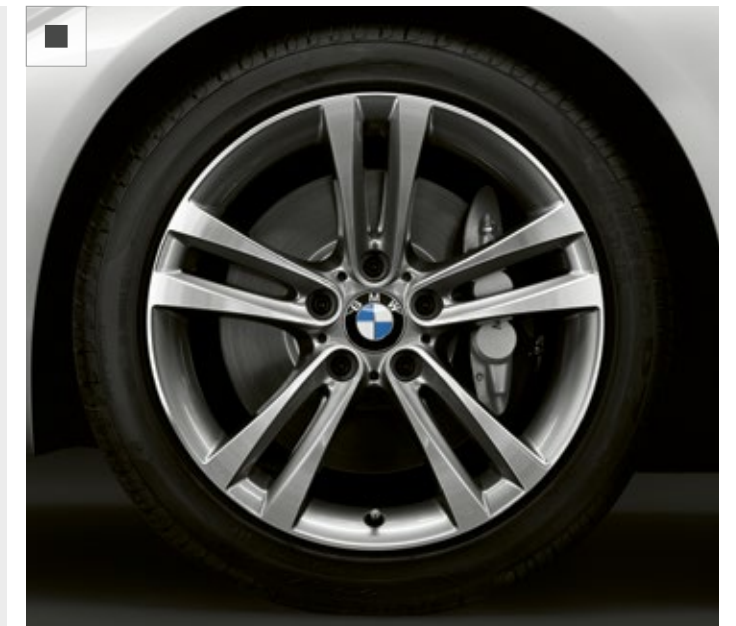

## 19" LIGHT ALLOY STAR-SPOKE STYLE 407 WHEELS, BICOLOUR ORBIT GREY.

19" light alloy Star-spoke style 407 wheels, Bicolour Orbit Grey with mixed run-flat tyres, front 8J x 19 with 225/40 R19 tyres and rear 8.5J x 19 with 255/35 R19.

Optional for Sport models.



## 19" M LIGHT ALLOY DOUBLE-SPOKE STYLE 400 M WHEELS.

18" M light alloy Double-spoke style 400 M wheels, front 8J x 18 with 225/45 R18 tyres, rear 8.5J x 18 with 255/40 R18 run-flat tyres.

Standard for M Sport models.





# GENUINE BMW ACCESSORIES.

## REAR BIKE CARRIER.

Rear bike carrier is lightweight yet sturdy and can carry up to 60kg. Exceptionally easy to use, it carries two bikes or e-bikes. Its tilt function allows easy access to the luggage compartment at all times.



## ALL-WEATHER FLOOR MATS.

The all-weather floor mats in Black protect your footwell from dirt and moisture.



## TRAVEL & COMFORT SYSTEM.

The Travel & Comfort system with iPad Holder and Safety Case protects your iPad and allows you to attach it to the headrest bars. Other tablet holders available.



## BMW M PERFORMANCE LIGHT ALLOY DOUBLE-SPOKE STYLE 405 M WHEELS.

The high-quality BMW M Performance light alloy Double-spoke style 405 M wheels featuring the iconic M badge, lend the BMW 4 Series Gran Coupé a strong athletic look.



## WIRELESS CHARGING CASE.

The wireless charging case for Apple iPhones allows you to charge your phone wirelessly. (Requires Enhanced Bluetooth with wireless charging).



## BMW M PERFORMANCE KIDNEY GRILLES, BLACK.

The BMW M Performance Black Kidney grilles are an easy way to customise your car and make it stand out.



## LUGGAGE COMPARTMENT MAT.

Fitted luggage compartment mat in Black with storage pockets and raised edge to protect the luggage compartment from dirt and spills.



Discover the all-round innovative solutions on offer in many categories: exterior, interior, communication & information and transport & luggage compartment. Your BMW Centre will be happy to advise you and provide information about the entire range of Genuine BMW Accessories. For further information, please visit [www.bmw.co.uk/accessories](http://www.bmw.co.uk/accessories). Image above also shows the BMW 4 Series Coupé and Convertible. The BMW 4 Series Coupé ceased production at the end of April 2020 and the BMW 4 Series Convertible ceased production at the end of June 2020. For further details, please speak to your local BMW Centre.



# PRICING INFORMATION.



	420i Sport	420i M Sport	420i xDrive Sport	420i xDrive M Sport	430i M Sport	440i M Sport
Basic price (excluding VAT)	£29,070.83	£30,195.83	£31,779.17	£32,904.17	£34,637.50	£39,720.83
VAT 20%	£5,814.17	£6,039.17	£6,355.83	£6,580.83	£6,927.50	£7,944.17
RRP (including VAT)	£34,885	£36,235	£38,135	£39,485	£41,565	£47,665
On the road price from	£36,660	£37,680	£39,910	£41,260	£43,340	£49,440
P11d value – Manual	£35,735	£37,085	-	-	-	-
P11d value – Automatic	£37,425	£38,775	£38,985	£40,335	£42,415	£48,515
BIK tax rate (2020 / 2021)	37% (37%-36%)	37% (37%-36%)	(37%)	(37%)	(37%)	(37%)
Insurance group	30	30	30	30	34	38
RDE2 Compliant (Y / N)	Y	Y	Y	Y	Y	Y

## PRICES AND SPECIFICATIONS

BMW (UK) Limited reserves the right to alter prices and specifications without notice. BMW (UK) Limited has made every effort to ensure the accuracy of information but does not accept liability for any errors or omissions.

## VED RATES

Annual VED (second year onwards), for cars costing over £40,000, is payable for five years. VED rates for brand new cars are determined by their CO<sub>2</sub> emissions figure. First year VED applies to the first year of ownership. Annual VED rates apply thereafter. The BMW 4 Series Gran Coupé models fall into one of the categories listed below:

CO <sub>2</sub> emissions (g/km)	1-50	51-75	76-90	91-100	101-110	111-130	131-150	151-170	171-190	191-225	226-255	Over 255
First year VED (petrol and RDE2 diesel)	£10	£25	£110	£135	£155	£175	£215	£540	£870	£1,305	£1,850	£2,175
First year VED (diesel)	£25	£110	£135	£155	£175	£215	£540	£870	£1,305	£1,850	£2,175	£2,175
Annual VED – second year onwards (standard rate for petrol and diesel cars)	£150	£150	£150	£150	£150	£150	£150	£150	£150	£150	£150	£150
Annual VED – second year onwards (petrol and diesel cars over £40,000)	£475	£475	£475	£475	£475	£475	£475	£475	£475	£475	£475	£475

## ON THE ROAD PRICE

The recommended on the road price includes:

Delivery and BMW Emergency Service	£825
Number plates	£25
Vehicle first registration fee	£55
First year Vehicle Excise Duty	See left

Figures in ( ) apply to cars with automatic transmission. Insurance group figures refer to 50 Group Rating System. Figures shown are for comparability purposes; only compare fuel consumption and CO<sub>2</sub> figures with other cars tested to the same technical procedures. These figures may not reflect real life driving results, which will depend upon a number of factors including the accessories fitted (post-registration), variations in weather, driving styles and vehicle load. The CO<sub>2</sub> figures have been determined according to the WLTP test. WLTP has been used as the applicable CO<sub>2</sub> figure from 1 April 2020 for first year vehicle tax (VED) and from 6 April 2020 for company car tax (BIK). The CO<sub>2</sub> figures were previously based on the NEDC equivalent.

# TECHNICAL INFORMATION.



	420i Sport	420i M Sport	420i xDrive Sport	420i xDrive M Sport	430i M Sport	440i M Sport
--	------------	--------------	-------------------	---------------------	--------------	--------------

Power output (hp)	184	184	184	184	252	326
0-62mph / 0-100km/h (secs)	7.5 (7.7)	7.5 (7.7)	(8.1)	(8.1)	(5.9)	(5.1)
Fuel consumption – combined (mpg)*	36.2-37.7 (36.2-38.2)	37.2-37.7 (37.2-38.2)	(34.9-36.2)	(35.8-36.2)	(37.2-37.7)	(34.0-34.9)
Fuel consumption – combined (l/100km)*	7.8-7.5 (7.8-7.4)	7.6-7.5 (7.6-7.4)	(8.1-7.8)	(7.9-7.8)	(7.6-7.5)	(8.3-8.1)
CO <sub>2</sub> emissions – combined (g/km)*	178-171 (177-169)	174-170 (173-169)	(185-178)	(181-178)	(174-171)	(189-185)

CO<sub>2</sub> value will vary dependent on vehicle specification. Build your BMW and view the CO<sub>2</sub> figure for your chosen model [here](#). \* = Figures shown are for comparability purposes; only compare fuel consumption and CO<sub>2</sub> figures with other cars tested to the same technical procedures. These figures may not reflect real life driving results, which will depend upon a number of factors including the accessories fitted (post-registration), variations in weather, driving styles and vehicle load. The CO<sub>2</sub> figures shown above have been determined according to the WLTP test. WLTP has been used as the applicable CO<sub>2</sub> figure from 1 April 2020 for first year vehicle tax (VED) and from 6 April 2020 for company car tax (BIK). The CO<sub>2</sub> figures were previously based on the NEDC equivalent. Figures in () apply to cars with automatic transmission.



# OPTIONAL EQUIPMENT PRICING.



	420i Sport	420i M Sport	420i xDrive Sport	420i xDrive M Sport	430i M Sport	440i M Sport	Price
<b>PAINTWORK</b>							
Non-metallic Available in Alpine White	■	■	■	■	■	■	Std
Metallic – Sport models: Available in Black Sapphire, Glacier Silver, Mineral Grey or Mineral White – M Sport models: Available in Black Sapphire, Carbon Black, Estoril Blue, Mineral Grey or Snapper Rocks Blue	□	□	□	□	□	■	£665
BMW Individual metallic Available in Aventurine Red II or Tanzanite Blue	-	□	-	□	□	-	£1,395
	-	-	-	-	-	□	£845
BMW Individual Frozen	-	□	-	□	□	-	£2,525
Frozen Bronze metallic	-	-	-	-	-	□	£1,880
<b>UPHOLSTERY</b>							
Dakota leather – Sport models Available in Black, Black with Oyster highlight, Black with Red highlight, Coral Red with Black highlight <sup>1</sup> , Ivory White and Mocha	■	-	■	-	-	-	Std
– M Sport models Available in Black, Black with Blue highlight, Black with Oyster highlight, Coral Red with Black highlight <sup>1</sup> , Ivory White and Mocha	-	■	-	■	■	■	Std
BMW Individual Extended Merino leather Available in Black, Cashmere Beige, Golden Brown, Nutmeg or Opal White Only with Anthracite headlining	-	□	□	□	-	□	£1,215
<b>INTERIOR TRIMS</b>							
Aluminium Carbon with Pearl Chrome finisher	-	□	-	□	□	□	£0
Aluminium Hexagon with Estoril Blue finisher	-	■	-	■	■	■	Std
Brushed Aluminium with High-gloss Black finisher	□	-	□	-	-	-	£155
	-	□	-	□	□	□	£0
Carbon Fibre Only with M Sport Plus Package	-	□	-	□	□	□	£500
Fine-line Anthracite wood with Pearl Chrome finisher	-	□	-	□	□	□	£100
High-gloss Black with Pearl Chrome finisher	■	-	■	-	-	-	Std
<b>BMW INDIVIDUAL INTERIOR TRIMS</b>							
Piano Black with Pearl Chrome finisher	-	□	-	□	□	□	£375

Only with = these options must be ordered together. <sup>1</sup> = Lower dashboard also in Coral Red.

■ Standard equipment □ Optional equipment - Not available



	420i Sport	420i M Sport	420i xDrive Sport	420i xDrive M Sport	430i M Sport	440i M Sport	Price
--	------------	--------------	-------------------	---------------------	--------------	--------------	-------

## TRANSMISSIONS

Sport automatic transmission	<input type="checkbox"/>	<input type="checkbox"/>	<input checked="" type="checkbox"/>	<input checked="" type="checkbox"/>	<input checked="" type="checkbox"/>	<input checked="" type="checkbox"/>	£1,690
------------------------------	--------------------------	--------------------------	-------------------------------------	-------------------------------------	-------------------------------------	-------------------------------------	--------

## PACKAGES

<b>COMFORT PACKAGE</b> Comprises: – Comfort Access – Extended storage – Steering wheel heating	<input type="checkbox"/>	<input type="checkbox"/>	<input type="checkbox"/>	<input type="checkbox"/>	<input type="checkbox"/>	<input type="checkbox"/>	£750
<b>DRIVING ASSISTANT PACKAGE</b> Comprises: – Active cruise control with Stop&Go function – Driving Assistant: – City Collision Mitigation – Forward Collision Warning – Lane Departure Warning – Preventive Pedestrian Protection – Lane change warning system Only with Technology Package + Exterior mirrors – folding with anti-dazzle	<input type="checkbox"/>	<input type="checkbox"/>	<input type="checkbox"/>	<input type="checkbox"/>	<input type="checkbox"/>	<input type="checkbox"/>	£1,200
<b>M SPORT PLUS PACKAGE</b> Comprises: – 19" M Double-spoke style 704 M wheels, Bicolour Jet Black – BMW Individual High-gloss Shadowline with extended contents – Digital Cockpit – Loudspeaker system – harman/kardon – M seat belts – M Sport braking system – Mirror caps, High-gloss Black – Sun protection glass	-	<input type="checkbox"/>	-	<input type="checkbox"/>	<input type="checkbox"/>	<input type="checkbox"/>	£2,000
Differing content: – 19" M Double-spoke style 704 M wheels, Ferric Grey	-	<input type="checkbox"/>	-	<input type="checkbox"/>	<input type="checkbox"/>	<input type="checkbox"/>	£0
<b>PARK ASSIST PACKAGE</b> Comprises: – Exterior mirrors – folding with anti-dazzle – Park Assist – Reversing Assist camera – Surround view	<input type="checkbox"/>	<input type="checkbox"/>	<input type="checkbox"/>	<input type="checkbox"/>	<input type="checkbox"/>	<input type="checkbox"/>	£1,200
<b>PREMIUM PACKAGE</b> Comprises: – Electric glass sunroof – Lumbar support, driver and front passenger – Seat adjustment – front, electric with driver memory	<input type="checkbox"/>	<input type="checkbox"/>	<input type="checkbox"/>	<input type="checkbox"/>	<input type="checkbox"/>	-	£1,800
	-	-	-	-	-	<input type="checkbox"/>	£1,100

Only with = these options must be ordered together.

■ Standard equipment   □ Optional equipment   - Not available





	420i Sport	420i M Sport	420i xDrive Sport	420i xDrive M Sport	430i M Sport	440i M Sport	Price
--	------------	--------------	-------------------	---------------------	--------------	--------------	-------

PACKAGES (CONT.)

<b>TECHNOLOGY PACKAGE</b> Comprises: Sport models: – Enhanced Bluetooth with wireless charging – Full Black Panel Display – Head-up Display – Navigation system – BMW Professional Multimedia – Speed limit display – WiFi hotspot preparation	<input type="checkbox"/>	-	<input type="checkbox"/>	-	-	-	£1,900
M Sport models: – Enhanced Bluetooth with wireless charging – Head-up Display – Speed limit display – WiFi hotspot preparation	-	<input type="checkbox"/>	-	<input type="checkbox"/>	<input type="checkbox"/>	<input type="checkbox"/>	£1,200
<b>VISIBILITY PACKAGE</b> Comprises: – BMW Icon Adaptive LED Headlights – High-beam Assistant	<input type="checkbox"/>	<input type="checkbox"/>	<input type="checkbox"/>	<input type="checkbox"/>	<input type="checkbox"/>	<input type="checkbox"/>	£495

STEERING & CHASSIS

Adaptive M Sport suspension	<input type="checkbox"/>	-	<input type="checkbox"/>	-	-	-	£750
Not with M Sport suspension (M Sport models)	-	<input type="checkbox"/>	-	<input type="checkbox"/>	<input type="checkbox"/>	<input type="checkbox"/>	£515
Variable Sport steering	<input type="checkbox"/>	<input type="checkbox"/>	<input type="checkbox"/>	<input type="checkbox"/>	<input type="checkbox"/>	<input type="checkbox"/>	£230

BMW EFFICIENT DYNAMICS

Auto Start-Stop	■	■	■	■	■	■	Std
Brake Energy Regeneration	■	■	■	■	■	■	Std
Drive Performance Control	■	■	■	■	■	■	Std
Electric Power Steering (EPS)	■	■	■	■	■	■	Std
Lightweight Engineering	■	■	■	■	■	■	Std
Optimum Shift Indicator	■	■	■	■	■	■	Std
Reduced Rolling Resistance Tyres	■	■	■	■	■	■	Std

Certain BMW EfficientDynamics features may be excluded depending on the optional equipment chosen. Your BMW Centre will be pleased to provide you with more information.



	420i Sport	420i M Sport	420i xDrive Sport	420i xDrive M Sport	430i M Sport	440i M Sport	Price
--	------------	--------------	-------------------	---------------------	--------------	--------------	-------

## SEATS

Lumbar support, driver and front passenger	<input type="checkbox"/>	<input type="checkbox"/>	<input type="checkbox"/>	<input type="checkbox"/>	<input type="checkbox"/>	<input type="checkbox"/>	£265
Split-folding rear seat	<input type="checkbox"/>	<input type="checkbox"/>	<input type="checkbox"/>	<input type="checkbox"/>	<input type="checkbox"/>	<input type="checkbox"/>	£170
Seat heating, rear	<input type="checkbox"/>	<input type="checkbox"/>	<input type="checkbox"/>	<input type="checkbox"/>	<input type="checkbox"/>	<input type="checkbox"/>	£280

## EXTERIOR EQUIPMENT

Exterior mirrors – electrically folding with anti-dazzle	<input type="checkbox"/>	<input type="checkbox"/>	<input type="checkbox"/>	<input type="checkbox"/>	<input type="checkbox"/>	<input type="checkbox"/>	£300
Exterior trim, Satin Aluminium	<input type="checkbox"/>	-	<input type="checkbox"/>	-	-	-	£155
Towbar, electric	<input type="checkbox"/>	<input type="checkbox"/>	<input type="checkbox"/>	<input type="checkbox"/>	<input type="checkbox"/>	<input type="checkbox"/>	£750
Trim designation deletion	■	<input type="checkbox"/>	■	<input type="checkbox"/>	<input type="checkbox"/>	<input type="checkbox"/>	£0

## INTERIOR EQUIPMENT

BMW Individual instrument panel finished in Nappa leather <sup>1</sup> Only with Extended storage / Lane change warning system / Driving Assistant / Active Cruise Control with Stop&Go function / Loudspeaker system – harman/kardon Only with M Sport Plus Package + Interior trim, Carbon Fibre	-	<input type="checkbox"/>	-	<input type="checkbox"/>	<input type="checkbox"/>	<input type="checkbox"/>	£815
BMW Individual instrument panel finished in leather <sup>1</sup> Only with Extended storage / Lane change warning system / Driving Assistant / Active Cruise Control with Stop&Go function / Loudspeaker system – harman/kardon Only with M Sport Plus Package + Interior trim, Carbon Fibre	-	<input type="checkbox"/>	-	<input type="checkbox"/>	<input type="checkbox"/>	<input type="checkbox"/>	£1,075
Headlining, Anthracite	<input type="checkbox"/>	■	<input type="checkbox"/>	■	■	■	£215
Sun protection glass	<input type="checkbox"/>	<input type="checkbox"/>	<input type="checkbox"/>	<input type="checkbox"/>	<input type="checkbox"/>	<input type="checkbox"/>	£320

## STEERING WHEELS

BMW Individual leather steering wheel Only with Sport multi-function leather steering wheel, three-spoke – Black	<input type="checkbox"/>	-	<input type="checkbox"/>	-	-	-	£50
Sport multi-function leather steering wheel, three-spoke – Black	<input type="checkbox"/>	-	<input type="checkbox"/>	-	-	-	£0
Steering wheel heating	<input type="checkbox"/>	<input type="checkbox"/>	<input type="checkbox"/>	<input type="checkbox"/>	<input type="checkbox"/>	<input type="checkbox"/>	£170

Only with = these options must be ordered together. <sup>1</sup> = Only available in combination with selected upholsterys and interior trims. For further details, please contact your local BMW Centre.

■ Standard equipment □ Optional equipment - Not available





	420i Sport	420i M Sport	420i xDrive Sport	420i xDrive M Sport	430i M Sport	440i M Sport	Price
--	------------	--------------	-------------------	---------------------	--------------	--------------	-------

## AUDIO & COMMUNICATION

Apple CarPlay® preparation <sup>1,2,3,4</sup>	□	□	□	□	□	□	£235
BMW Emergency Call <sup>3</sup>	■	■	■	■	■	■	Std
BMW Navigation System	■	-	■	-	-	-	Std
BMW Online Services <sup>1,5</sup>	■	■	■	■	■	■	Std
BMW TeleServices <sup>3</sup>	■	■	■	■	■	■	Std
Concierge Services <sup>1,5</sup>	□	□	□	□	□	□	£240
DAB tuner	■	■	■	■	■	■	Std
Enhanced Bluetooth with wireless charging Only with WiFi hotspot preparation	□	□	□	□	□	□	£395
Full Black panel display	□	■	□	■	■	■	£140
Loudspeaker system – harman/kardon	□	□	□	□	□	□	£675
Online Entertainment <sup>1,6</sup>	□	□	□	□	□	□	£160
Real Time Traffic Information (RTTI) <sup>1,5</sup>	■	■	■	■	■	■	Std
Remote Services <sup>1,3</sup>	■	■	■	■	■	■	Std
WiFi hotspot preparation <sup>7</sup> Only with Enhanced Bluetooth with wireless charging	□	□	□	□	□	□	£0





Only with = these options must be ordered together. <sup>1</sup> = Requires a free BMW ConnectedDrive account. <sup>2</sup> = Compatibility and functions may vary due to the model year of the iPhone® and the version of software installed on it. Functions using a data connection will use data from the SIM card in the iPhone®. Additional data charges may be applied by the mobile network provider. <sup>3</sup> = Available and active without runtime limitations. Usage cannot be guaranteed permanently due to potential future technical developments (of the Service availability and/or Smartphone compatibility/operating systems). <sup>4</sup> = Please note for purchases of Apple CarPlay® via the ConnectedDrive store after production, vehicles must be fitted with Enhanced Bluetooth with wireless charging. <sup>5</sup> = Active for three years, renewable thereafter. <sup>6</sup> = Includes subscription to a chosen music partner for one year. <sup>7</sup> = Data subscription costs apply and must be purchased separately.

■ Standard equipment □ Optional equipment - Not available

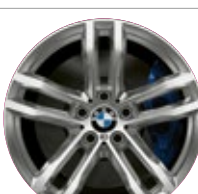

420i Sport	420i M Sport	420i xDrive Sport	420i xDrive M Sport	430i M Sport	440i M Sport	Snow chains	Run-flat tyres	Price
------------	--------------	-------------------	---------------------	--------------	--------------	-------------	----------------	-------

LIGHT ALLOY WHEELS

	18" Double-spoke style 397, Bicolour Orbit Grey	■	-	■	-	-	-	■	Std
	18" M Double-spoke style 400 M	-	■	-	■	■	■	-	Std
	19" Double-spoke style 407, Bicolour Orbit Grey	□	-	□	-	-	-	■	£800
	19" M Double-spoke style 704 M	-	□	-	□	□	□	-	n/a
	Only with M Sport Plus Package								
	19" M Double-spoke style 704 M, Bicolour Jet Black	-	□	-	□	□	□	-	n/a
	Only with M Sport Plus Package								
	19" M Star-spoke style 403 M	-	□	-	□	□	□	-	£700

See [Wheels & Tyres](#) for further details. Only with = these options must be ordered together.

■ Standard equipment □ Optional equipment - Not available



# DIMENSIONS.

## THE BMW 4 SERIES GRAN COUPÉ.

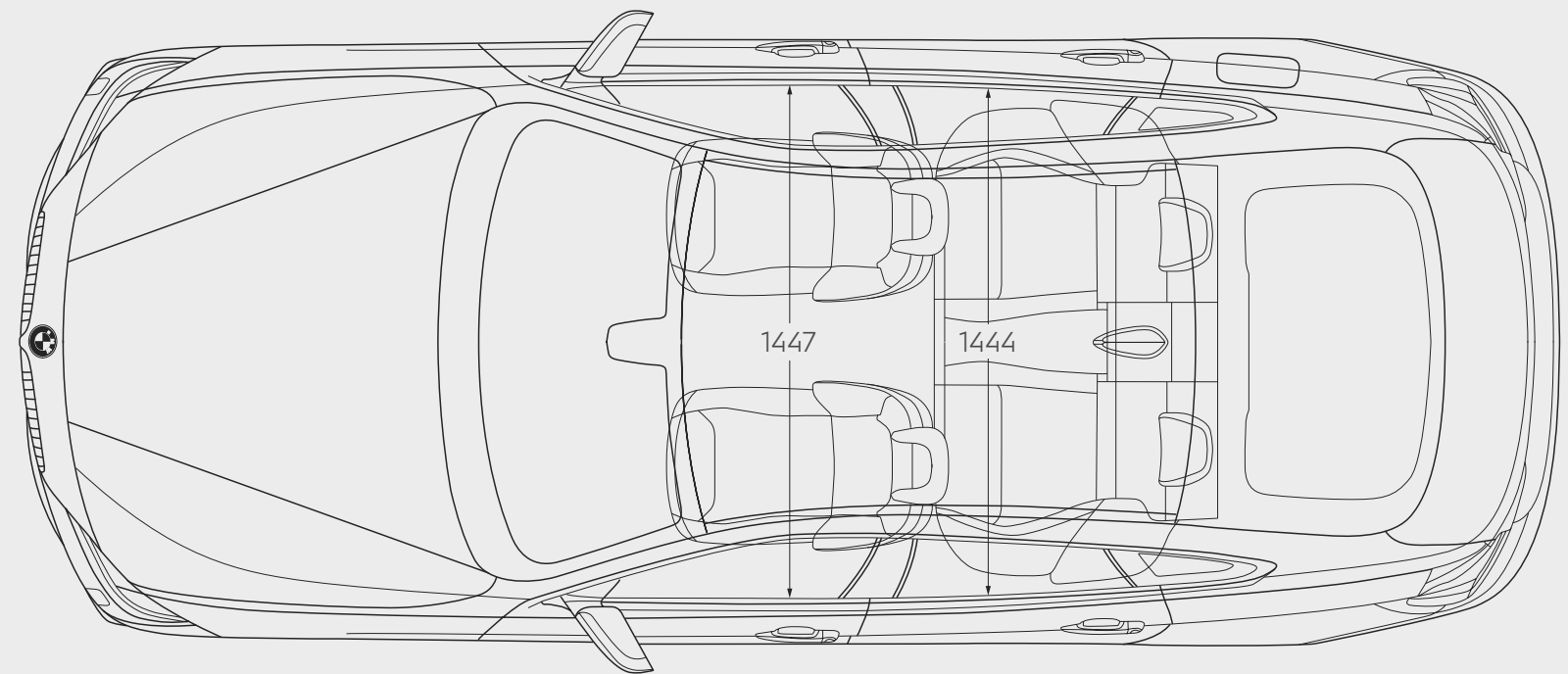
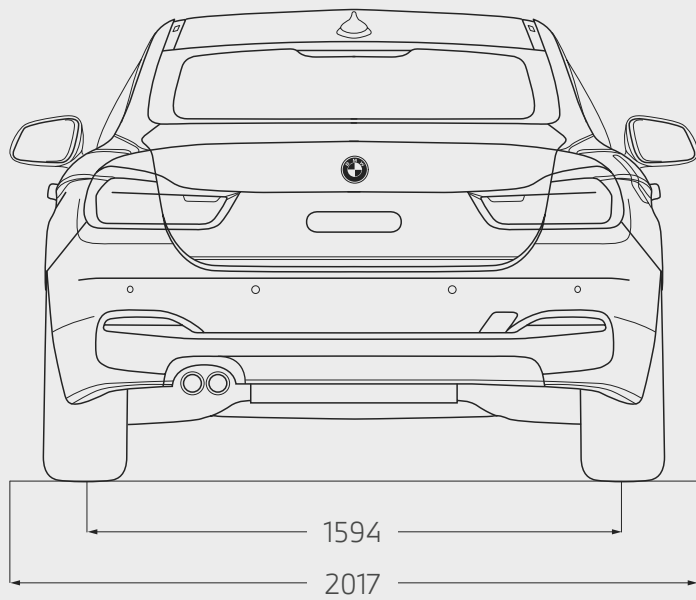
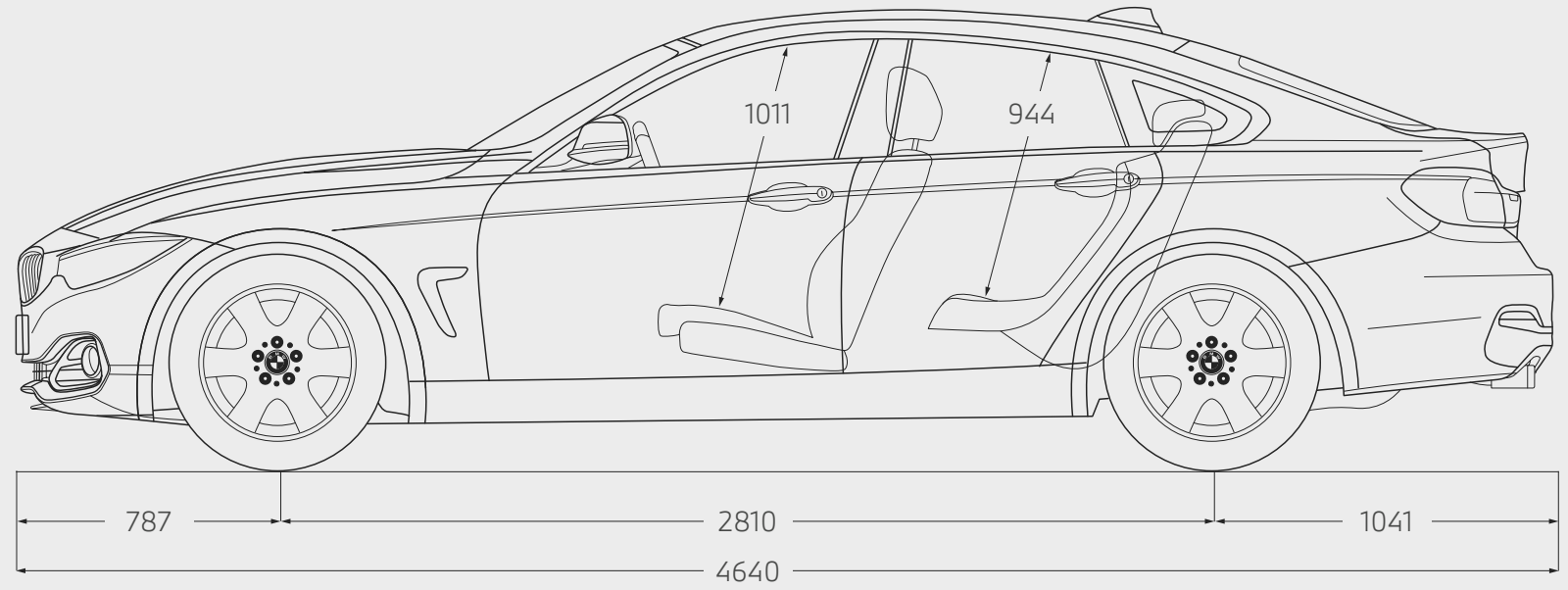
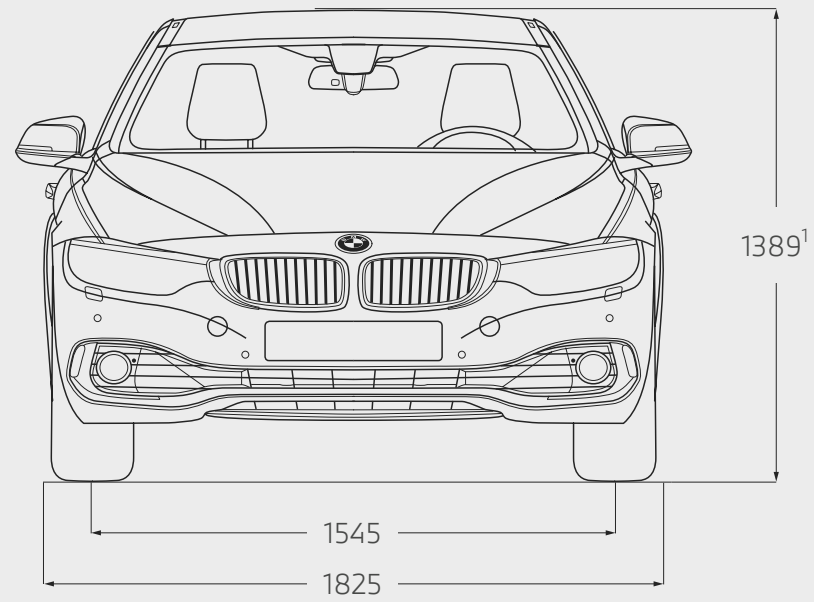

Length (mm)	4640	Height (mm)	1389 <sup>1</sup>	Number of seats	5	Turning circle (m)	11.3 <sup>2</sup>
Width (mm)	1825	Width including mirrors (mm) (Driver / Passenger)	2017 (1020 / 997)	Wheelbase (mm)	2810	Luggage capacity (litre)	480-1300

<sup>1</sup> = 420i xDrive: 1404mm. <sup>2</sup> = 420i xDrive: 11.8m.

# BMW PAY MONTHLY SERVICING & TRACKSTAR.

## SERVICING MADE SIMPLE.

Planning for the road ahead has never been easier. With the BMW Pay Monthly Service Plan<sup>1</sup> you can remove the uncertainty often associated with car servicing costs by spreading them monthly, much like you would your household bills. Our Pay Monthly service plan covers two services and any unused credit can be transferred to another BMW if you decide to switch unexpectedly. As part of the Pay Monthly plan you will also receive a number of added extras including:

- Fluid top ups
- An MOT
- A Wash & Vac each time you visit
- Seasonal health checks
- Sat Nav Map updates

Get the quality service and parts you expect from BMW with a fixed monthly payment. Give your BMW the care and attention it deserves from the experts that made it.

**Price: £25 per month for 36 months**

Please contact your preferred BMW Centre for further information.

## BMW TRACKSTAR.

Locate and recover your vehicle if it is stolen with BMW Trackstar or BMW Trackstar Advance. Benefits include:

- 24/7 Trackstar Monitoring Centre
- Thatcham accredited
- Integrated motion sensor
- Pan-European protection

**BMW Trackstar S7 price from: £3992**

**BMW Trackstar S5 price from: £5492**

**BMW Trackstar S5 Advance price from: £6492**





# BMW CONNECTED DRIVE SERVICES.

BMW ConnectedDrive keeps driver and vehicle connected with the outside world. Digital services, driver-focused technologies and driver assistance systems provide more comfort, more entertainment and more safety. Increase your driving pleasure – with BMW ConnectedDrive.

For further information on BMW ConnectedDrive and the General Terms and Conditions of Service for ConnectedDrive, please see: [www.bmw.co.uk/connecteddrive-information](http://www.bmw.co.uk/connecteddrive-information)

The BMW ConnectedDrive Hotline is available on: +44 (0) 800 561 0555 from Monday to Friday 8am – 7pm and Saturday to Sunday 9am – 5pm.

## CONNECTED DRIVE SERVICES DURATION

Online Entertainment	1 year
BMW Online Services	3 years
Concierge Services	3 years
Real Time Traffic Information	3 years
Apple CarPlay® preparation	Available and active without runtime limitations.
BMW Emergency Call	Available and active without runtime limitations.
BMW TeleServices	Available and active without runtime limitations.
Remote Services	Available and active without runtime limitations.

## GENERAL INFORMATION

BMW (UK) Ltd, Summit ONE, Summit Avenue, Farnborough, Hampshire, GU14 0FB (hereinafter referred to as "BMW") provides the customer with certain vehicle-related information and assistance functions (hereinafter called "Services") under the name of "BMW ConnectedDrive". BMW (UK) Limited is the data controller. BMW collects, stores or processes car-related data in compliance with applicable law and only to the extent necessary to provide the Services. BMW does not collect, store or process personal data in course of the Services – except where this is explicitly stated in the service description of the individual Services. In the case of Services that require personal data to be collected, stored and processed so that such Services can actually be provided, BMW informs customers of this in advance by providing this data protection notice. The Services are provided by means of a SIM card installed in the vehicle.

## AVAILABILITY OF THE SERVICE

The complete range of Services is only available for customers whose vehicles are approved in United Kingdom, and only within United Kingdom. "BMW Emergency Call" is available to customers in United Kingdom, Germany, Austria, Italy, San Marino, Vatican, France, Monaco, Switzerland, Liechtenstein, Belgium, Luxembourg, the Netherlands, Ireland, Spain, Andorra, Portugal, Sweden, Norway, Czech Republic, Poland, Turkey and Russia "TeleServices", "Concierge services", "Remote Services" and "BMW Online" can be accessed on any mobile communication network in Europe. When used abroad, the range and characteristics of the service may vary from the range and characteristics described above and may vary from country to country. "Real Time Traffic Information" is available in United Kingdom, Germany, Austria, Italy, France, the Netherlands, Switzerland, Belgium, Republic of Ireland, Spain, Portugal, Sweden and Norway. "Online Entertainment" is available for use in United Kingdom, Germany, France, Italy, Spain, Belgium, Luxembourg, the Netherlands, Austria and Switzerland.

## DEACTIVATION

You can have the BMW ConnectedDrive services deactivated through an authorised BMW centre, a BMW subsidiary or a BMW authorised workshop at any time. This also has the consequence that aspects of the emergency call in the vehicle as well as all remaining Services will no longer function.

You can additionally arrange for the remaining Services to be deactivated via "My BMW ConnectedDrive".

If the vehicle is equipped with the legally required EU Emergency Call (as from April 2018) a deactivation of the BMW ConnectedDrive basic services will not deactivate the vehicle's built-in SIM card. It has to remain active, so that the EU Emergency Call is functional all the time.

Services that are available and active without runtime limitations, cannot be guaranteed for permanent usage due to potential future technical developments (of the Service availability and/or Smartphone compatibility/operating systems).







READY TO TAKE THE NEXT STEP?